

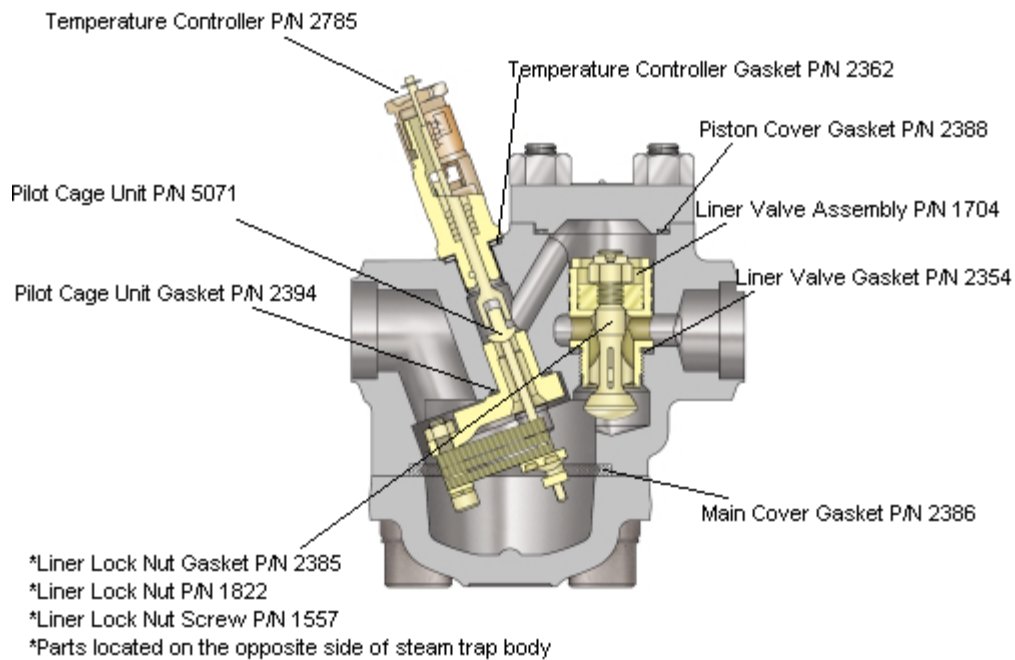

SPF4-200 Repair Kit

- (1) Pilot Cage Unit Part Number 5071
- (1) Temperature Controller Part Number 2785
- (1) Pilot Cage Unit Gasket Part Number 2394
 - (1) Liner Valve Gasket Part Number 2354
 - (1) Liner Valve Assembly Part Number 1704
- (1) Temperature Controller Gasket Part Number 2362
 - (1) Main Cover Gasket Part Number 2386
 - (1) Piston Cover Gasket Part Number 2388
- (1) Liner Locknut Gasket Part Number 2385
 - (1) Liner Lock Nut Part Number 1822
 - (1) Liner Lock Nut Screw Part Number 1557



*Tool required for repair:
Liner Valve Removal Tool Part Number L99051